

Features

- Triac dimmable
- Compatible with leading edge and trailing edge dimmers
- THD ≤20%
- Output current adjustable via DIP switch
- Flicker free
- IP20
- Suitable for Class II light fixtures
- 5-year warranty (please refer to the warranty condition)

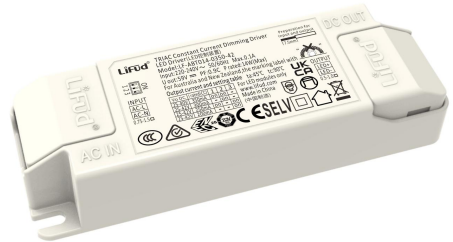

Applications

· Panel light · down light · spot light

Descriptions

LF-ABT014-0350-42 is a 14W (max.) constant current Triac dimmable LED driver. Its rated input voltage ranges from 220 to 240Vac and output current is adjustable from 200 to 350mA via DIP switch with every 50mA as a step. Besides, it is compatible with leading edge and trailing edge dimmers and has all-round protections: over voltage protection and short circuit protection.

Product Model

LF - ABT 014 - 0350 - 42

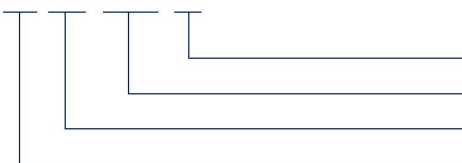

- 42: max. output voltage: 42V
- 0350: max. output current: 350mA
- 014: rated power: 14W
- ABT: external Triac dimmable LED driver

■ Electrical Characteristics

Model		LF-ABT014-0350-42				
Output	Output Voltage	25-42V	25-42V	25-42V	25-40V	
	Output Current	200mA	250mA	300mA	350mA	
	Flicker Index	IEC-Pst \leq 1, CIE SVM \leq 0.4 Complies with flicker-free standard IEEE Std 1789-2015				
	Current Tolerance	\pm 5%				
	Temperature Drift	\pm 10%				
	Start-up Time	<2S@230Vac				
Input	Input Voltage	220-240Vac (voltage limit: 198-264Vac)				
	DC Input Voltage	180-264Vdc				
	Input Frequency	0/50/60Hz				
	Input Current	0.1A max.				
	PF	\geq 0.9				
	THD	\leq 20% @350mA/40V				
	Efficiency	\geq 75%	\geq 76.5%	\geq 77.5%	\geq 77%	
	Inrush Current	<2.5A&35uS @230Vac				
	Loading Quantities of Circuit Breaker	Model	B10	C10	B16	C16
		Quantity (pcs)	66	66	106	106
Leakage Current	\leq 0.7mA					
Protection Characteristics	Open Circuit	<59V				
	Short Circuit	No damage (auto-recovery)				
Environment Descriptions	Operating Temperature	-20°C~+45°C				
	Operating Humidity	20-90%RH (no condensation)				
	Storage Temperature/ Humidity	-30°C~+80°C (6 months in Class I environment); 10-90%RH (no condensation)				
	Atmospheric Pressure	86-106kPa				

■ Electrical Characteristics

Safety & EMC	Certifications	TUV-ENEC, CE-LVD, CB, UKCA, RCM, CCC
	Withstanding Voltage	I/P-O/P: 3.75kVac 5mA 60S
	Insulation Resistance	I/P-O/P: >100MΩ@500Vdc
	Safety Standards	ENEC: EN61347-1: 2015, EN 61347-2-13: 2014/A1: 2017, EN 62384: 2016/A1: 2009 CE-LVD: EN 61347-2-13: 2014/A1: 2017, EN 61347-1: 2015, EN 62493: 2015 CB: IEC 61347-1: 2015, IEC61347-2-3: 2014, IEC 61347-2-13: 2014/AMD1: 2016 SAA: AS 61347.2-13: 2018 CCC: GB19510.1-2009, GB19510.14-2009
	EMI	CE-EMC/RCM: EN55015, EN61000-3-2, EN61000-3-3 CCC: GB/T17743, GB17625.1, GB17625.2
	EMS	CE-EMC/RCM: EN61000-4-2, 3, 4, 5 (L-N: 1kV), 6, 11 CCC: GB/T17626.2, 3, 4, 5 (L-N: 1kV), 6, 11
Other Parameters	IP Rating	IP20
	RoHS	RoHS 2.0 (EU) 2015/863
	Warranty	5 years (Tc≤80°C)
	Noise Level	≤29dB (this data is measured in a soundproof room and the noise collector should be 10CM away from LED driver)
Compatible Dimmers	Hamiton: L400/G, YIKAI: EU200P, CLIPSAL: 32E45LM, MK: K4501, CRESTRON SYSTEM: DIN-IDIM4, LUTRON SYSTEM: LQSE-4A-D, HDL SYSTEM: MD0602.432, CLIPSAL: 32ELEDM	
Test Equipment	AC power source: CHROMA6530, digital power meter: CHROMA66202, oscilloscope: Tektronix DPO3014, DC electronic load: M9712B, LED board, constant temperature and humidity chamber, lightning surge generator: Everfine EMS61000-5B, rapid group pulse generator: Everfine EMS61000-4A, spectroanalyzer: KH3935, withstanding voltage tester: EEC SE7440, flicker tester (flicker-free coefficient test) Everfine LFA-3000, etc.	
Test Remark	If there are no special remarks, the above parameters are tested at the ambient temperature of 25°C, humidity of 50%, full load and input voltage of 230Vac/50Hz.	
Additional Remarks	<ol style="list-style-type: none"> 1. It is recommended that user install the over voltage protection, under voltage protection and surge protection devices in the power supply circuits of light fixtures to ensure electricity safety. 2. The LED driver used in combination with the end device is one of the accessories of the whole light fixture, and the EMC of the whole light fixture is not only susceptible to the driver itself, but to the LED light fixture and the whole light fixture's wiring. Thus, the manufacturer of LED light fixture should re-confirm the EMC of the whole light fixture before the whole light fixture is finished. 3. The test conditions of the circuit breaker configuration quantity are the same as those of the inrush current. 4. Lifud reserves the right to interpret any of the above parameters. 	

■ **Product Characteristic Curves**

Efficiency Curve

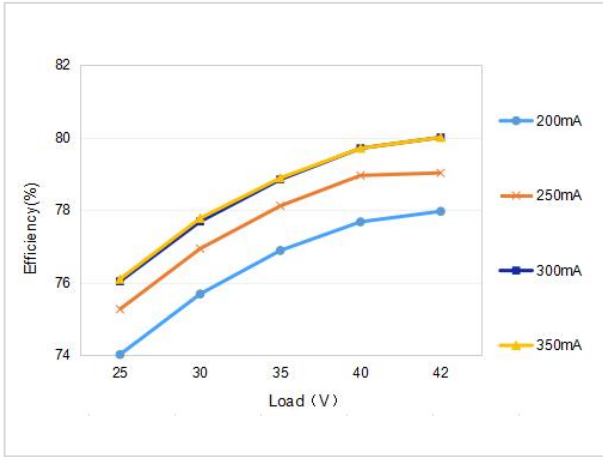

PF Curve

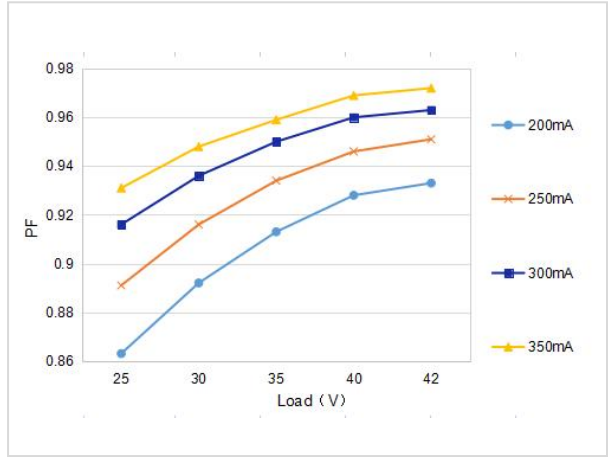

Lifetime Curve

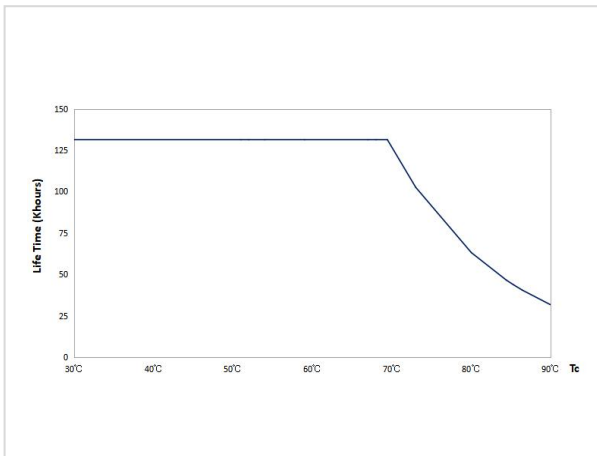

Tc Point Test Diagram

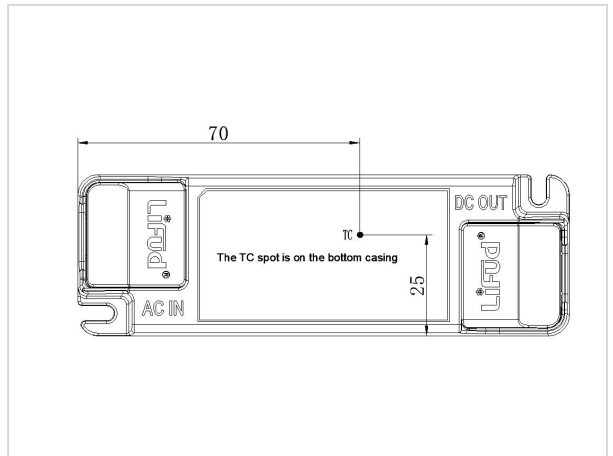

■ **Product Definitions**

Product terminals

INPUT	
AC-L	Input terminal of AC live wire
AC-N	Input terminal of AC neutral wire

OUTPUT	
LED+	Positive electrode output of LED driver
LED-	Negative electrode output of LED driver

Product Definitions

Product DIP Switch

Vo DC	I rated (CC)	1	2	3
25-40V	350mA	ON	ON	-
25-42V	300mA	-	ON	-
25-42V	250mA	ON	-	ON
25-42V	200mA	-	-	ON

Remark: when adjusting the output current via the DIP switch, please disconnect input AC power supply first; when using the DIP switch, pay attention: 350-300mA PIN3 OFF & 200-250mA PIN3 ON; the output current is relatively low on the condition of 300-350mA PIN3 ON.

Triac Dimming Operation Instructions

Triac Dimming Operations

- Connect AC live wire to the input of dimmer and the output wire of dimmer to AC-L;
- Connect AC neutral wire to AC-N
- Dimming range: 0-100%

Wiring Diagram of Triac Dimming

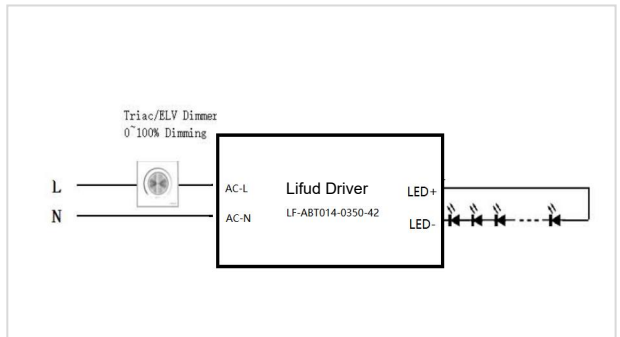

Triac Dimming Operation Instructions

Triac Dimming Curve 1



Leading Edge Dimmer MD0602.432: Minimum to Maximum Dimming Curve

Triac Dimming Curve 2

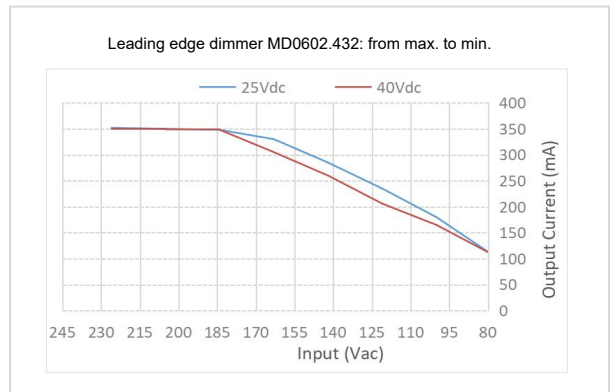

Leading Edge Dimmer MD0602.432: Maximum to Minimum Dimming Curve

■ **Triac Dimming Operation Instructions**

Triac Dimming Curve 3



Trailing Edge Dimmer 32ELEDM: Minimum to Maximum Dimming Curve

Triac Dimming Curve 4

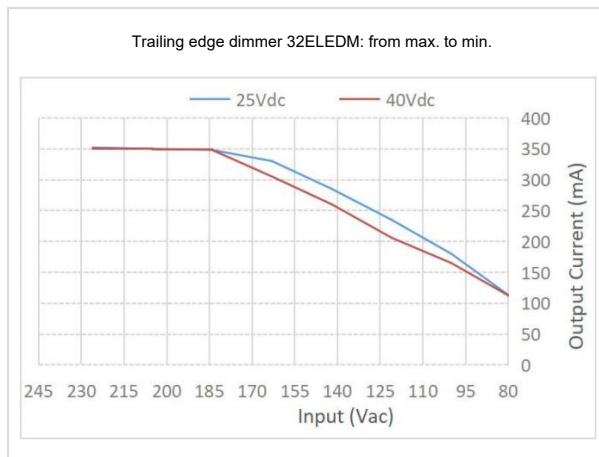

Trailing Edge Dimmer 32ELEDM: Maximum to Minimum Dimming Curve

■ **Label**

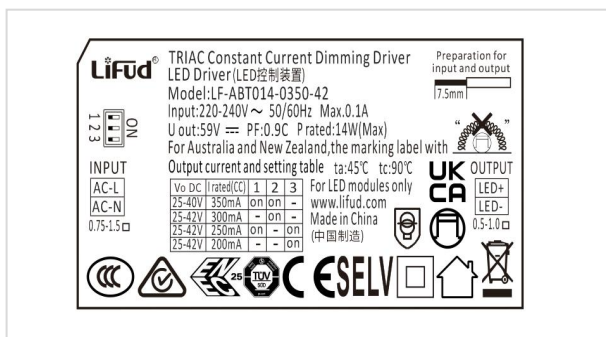

■ **Product Structure Diagram**

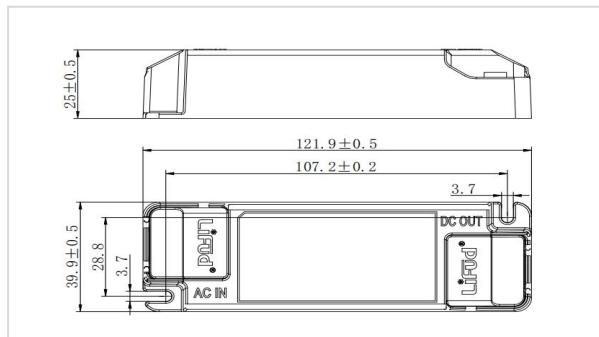

■ **Structure & Dimensions (unit: mm; tolerance: ±0.5mm)**

Product Dimensions

Model	Overall Appearance (L*W*H)	Distance Between 2 Positioning Holes	Diameter of Positioning Hole
LF-ABT014-0350-42	121.9*39.9*25 mm	107.2 mm	3.7 mm

■ Packaging Specifications

Model	LF-ABT014-0350-42
Carton Size	385*285*210 mm (L*W*H)
Quantity	14 pcs/layer; 7 layers/ctn; 98 pcs/ctn
Weight	0.077 kg/pc; 7.546 kg/ctn

■ Transportation and Storage

1. Transportation

- Suitable transportation means: vehicles, boats and aeroplanes.
- In transit, it is necessary to prepare awnings for rain or sun protection. Moreover, please keep civilized loading and unloading to prevent the vibration or impact of LED driver as much as possible.

2. Storage

- The storage of LED driver shall conform to the standard of Class I environment. When using LED drivers which have been stored for more than 6 months, please re-test them firstly. Do not use them unless they are tested to be qualified.

Cautions

- Please use Lifud LED driver according to its parameters in the specification, otherwise the LED driver may malfunction.
- Using any incompatible light fixtures or those that have not been certified may cause fire, explosion or other risks.
- Man-made damage is beyond the scope of Lifud warranty service.

Remark: Lifud Technology Co., Ltd. reserves the right to interpret any contents of this specification.