

# BENDABLE

## MEDIUM

LL-PR-BND -1907

19x7

### Type

<b>Mounting</b>	Surface
<b>Lens (Cover)</b>	Opal (40~30% light transmission) Diffused (80~70% light transmission) Clear (95~85% light transmission) Black
<b>Profile Colour</b>	Anodised Silver - stocked Anodised Black - indent* Painted White - indent* Custom Powder Coating - optional*
<b>End Cap Colour</b>	White Grey - indent* Black - indent* Silver - indent*

### Material

<b>Profile</b>	Aluminium: 6063-T5 Anodised Thickness: 10µm
<b>Cover</b>	Polycarbonate (fire rating: V2) UV Resistant
<b>End Caps</b>	Polycarbonate (fire rating: V2) UV Resistant
<b>Mounting Brackets</b>	Stainless Steel

### Dimensions

<b>Width (outer)</b>	18.9 mm
<b>Height (outer)</b>	7.0 mm
<b>Width (inner)</b>	15.5 mm
<b>Length</b>	3 m
<b>Max LED tape width</b>	14.0 mm

### Accessories

<b>Mounting Clips</b>	6 each
<b>End Caps</b>	3 pairs (3x with cable entry, 3x blank)

\*indent items are not stocked, lead-times apply

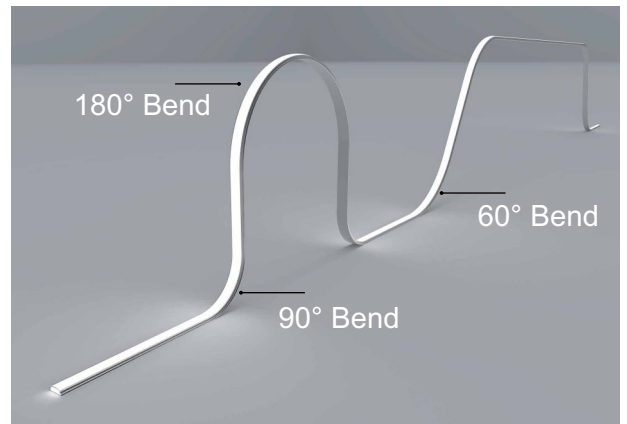
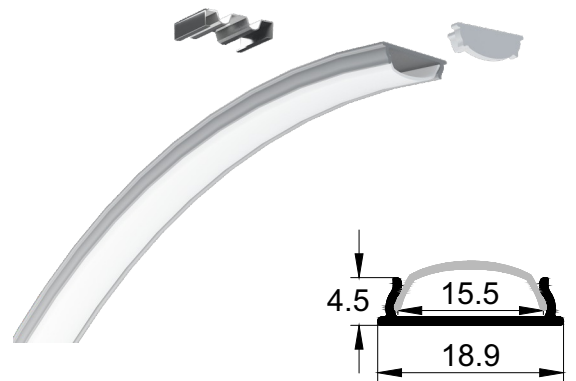

### ALUMINIUM FINISH



### MIN. BENDING RADIUS

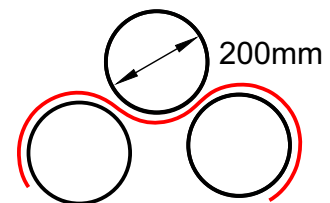

### COVER TYPES

