

42W DALI + PUSH Dimming power supply

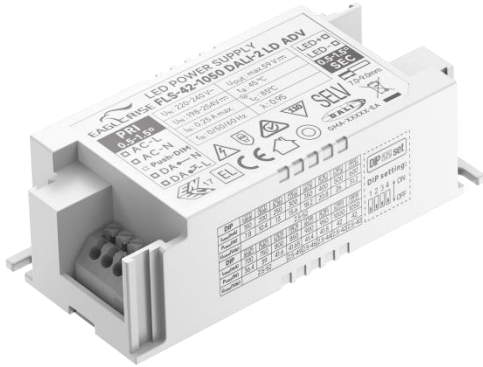

■ Approve



Features

- For luminaries of protection Class I, II, SELV, Built-in/Independent (With side caps)
- Input Voltage: 220-240VAC
- Protections: SCP/OLP/OVP/OTP
- Power Factor: 0.95
- Efficiency: 87%
- Support DALI-2, Push Dimming
- 5 years warranty
- DALI maintainace(Part 251,252,253)

Applications

- LED panel、LED down light
- LED spot light

◆ Description

FLS-42-1050 DALI-2 LD ADV is a 42W constant current LED driver with 150 to 1050mA output current and a forward voltage range from 2.5 to 52Vdc. The output current is adjustable by DIP Switch. With it's dimensions from 97 x 43 x 30 mm. It is easy to integrate in LED Panel and down light products. To ensure trouble-free operation, protection is provided against output short circuit and over Load.

◆ Model code

FLS-42-1050 DALI-2 LD ADV

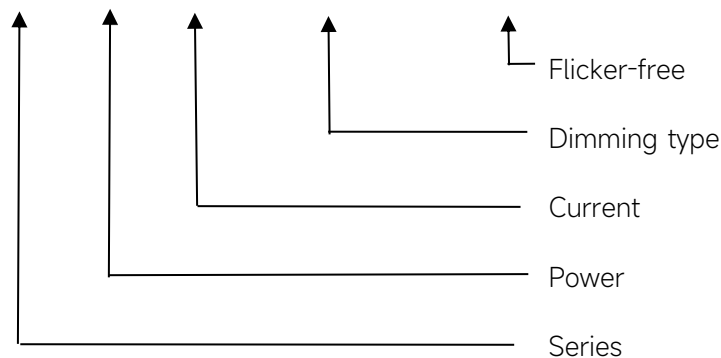

◆ Specification

Output	Constant Current (mA)	150mA	200mA	1000mA	1050mA
	Voltage Range(VDC)	2.5-52VDC	2.5-52VDC	2.5-42VDC	2.5-40VDC
	Unload voltage Max.(VDC)	59VDC				
	Current Accuracy	±6%@150-300mA;±5%@350-1050mA				
	Output HF current ripple(≥1KHz)	±5%				
	Output LF current ripple(≤120Hz)	±3%				
	SVM	≤0.01@Full Load				
	P _{st}	≤0.05@Full Load				
	Efficiency(Typ.)	87%@full load, 230V				
Input	Rated input voltage(VAC)	220-240VAC				
	Range of input voltage(VAC)	198-264VAC				
	Range of input voltage(VDC)	198-280VDC				
	Frequency(Hz)	0/50/60 Hz				
	Displacement factor	≥0.9@full load, 230V				
	Power Factor(Typ.)	0.95@full load, 230V				
	Input Current max	0.26A max				
	Start-up time	< 0.7S				
	No Load Power	≤0.5W				
	Standby Power	≤0.5W				
	THD (Typ.)	<10%@full load, 230V				
Dimming	Dimming	YES				
	Dimming mode	DALI-2 (IEC 62386-101,102,207,251,252,253) & Push Dimming (Corridor Function) *				
	Dimming depth	1%				
	Dimming current range	1 ~100%				
Protection	Over Load Protection	103-120% YES/Latch off				
	Over Voltage Protection	59VDC YES/Latch off				
	Short circuit Protection	YES/Latch off				
	Over Temperature Protection	YES/Auto Resume				
Environment	Operating Temperature	-20°C~+45°C				
	Humidity	20%-90%RH				
	Tc	85°C				
	Storage Temperature	-40°C~+80°C				
	Life time	> 50000h,@TC=85°C				

Surface	Dimension	97 x 43 x 30 mm (With side caps) : 131X43X30mm
standards	EN 61347-1; EN61347-2-13; EN62384; EN55015; EN61000-3-2 ; EN61000-3-3; EN 61547	
Others	ErP	EU 2019/2020
	RoHS	RoHS (2011/65/EU) (EU)2015/863
DALI performance	EN 62386-101 (DALI-2) EN 62386-102 (DALI-2) EN 62386-207 (DALI-2,including part251,252,253)	
Note	<p>1.All parameters NOT specially mentioned are measured at 230VAC input , full load and 25°C of ambient temperature.</p> <p>2.Ripple & Noise are measured at 20MHz of bandwidth by using a 300mm twisted pair-wire terminated with a 0.1uF & 47 uF parallel capacitor.</p> <p>3.The DC input for this product is only used for emergency lighting and applies to functional and safety requirements, EMC is not considered.</p> <p>*4.DALI protocol comprises 16 groups and 64 addresses.Up to 32 drivers can perform the PUSH dimming at the same time when utilizing one push button.</p> <p>5.Switch and dimmer are not recommended to connect between this product output and luminaries.</p>	

◆ Parameter

Number	Output				Switch position			
	Current (mA)	Voltage (VDC)	Voltage No load (VDC)	Power (W)	1	2	3	4
1	150mA	2.5-52VDC	59VDC	7.8W	--	--	--	--
2	200mA			10.4W	ON	--	--	--
3	250mA			13W	--	ON	--	--
4	300mA			15.6W	ON	ON	--	--
5	350mA			18.2W	--	--	ON	--
6	400mA			20.8W	ON	--	ON	--
7	500mA			26W	--	ON	ON	--
8	600mA			31.2W	ON	ON	ON	--
9	700mA			36.4W	--	--	--	ON
10	750mA			39W	ON	--	--	ON
11	800mA			41.6W	--	ON	--	ON
12	850mA	2.5-49VDC		41.65W	ON	ON	--	ON
13	900mA	2.5-46VDC		41.4W	--	--	ON	ON
14	950mA	2.5-44VDC		41.8W	ON	--	ON	ON
15	1000mA	2.5-42VDC		42W	--	ON	ON	ON

*16	1050mA	2.5-40VDC		42W	ON	ON	ON	ON
-----	--------	-----------	--	-----	----	----	----	----

* Factory default

◆ Circuit Breaker

I _{peak}	T _{width}	B10	B16	B20	C10	C16	C20
5.36A	48μs	30pcs	49pcs	61pcs	30pcs	49pcs	61pcs

◆ Wiring diagram

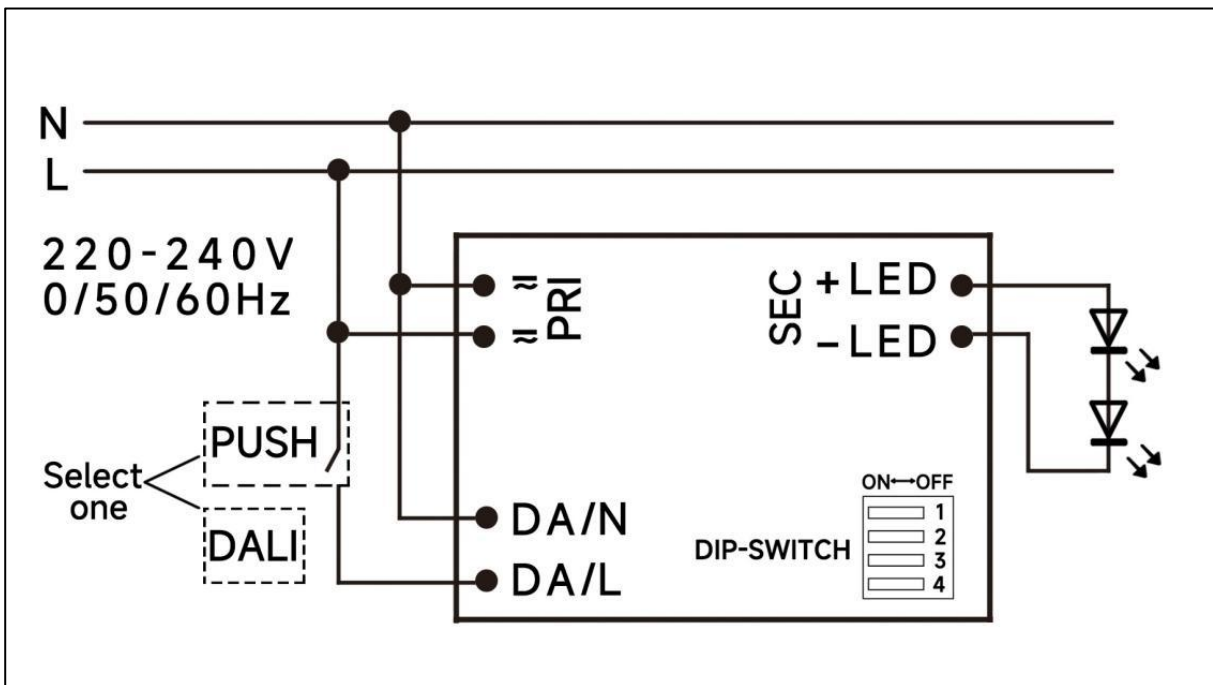

◆ 2D diagram

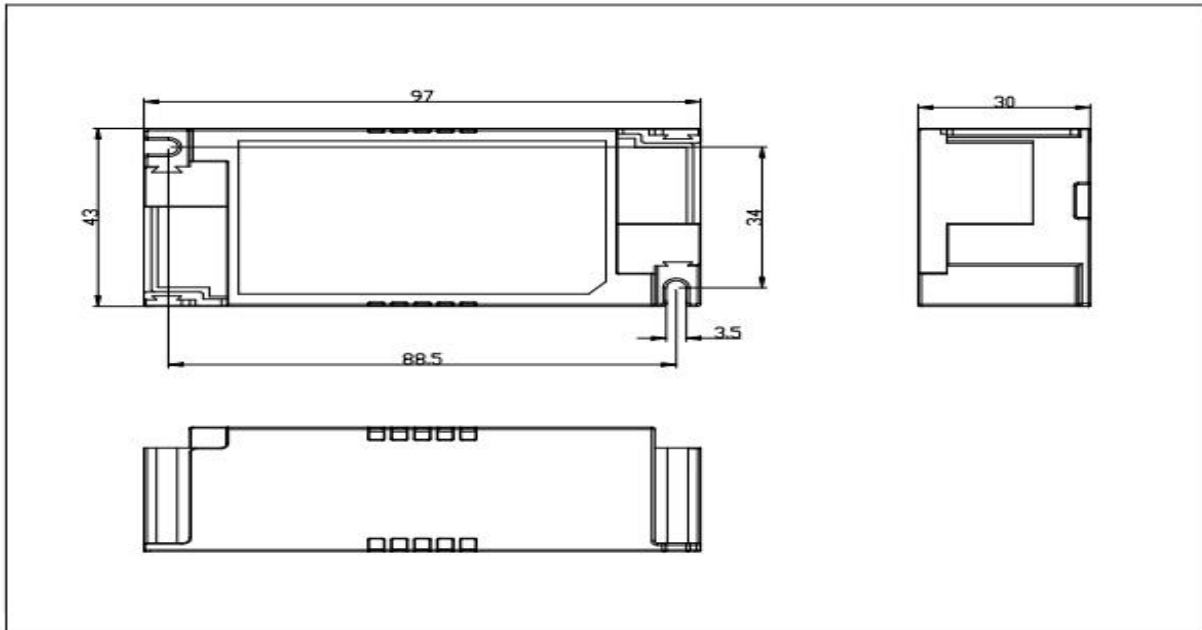

With side caps

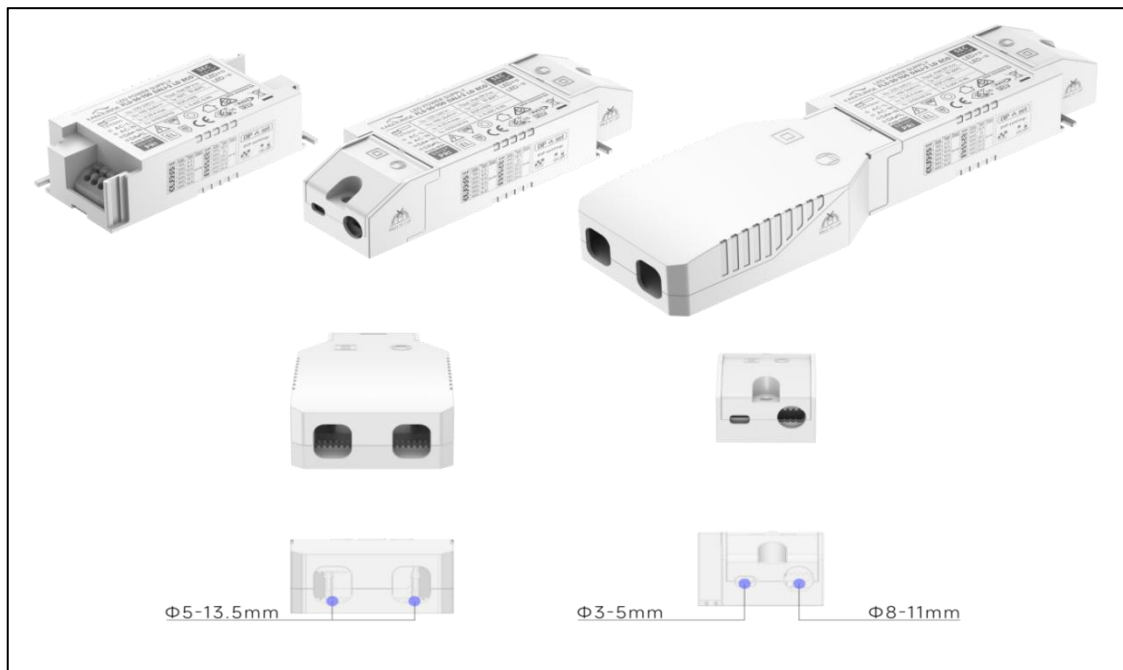

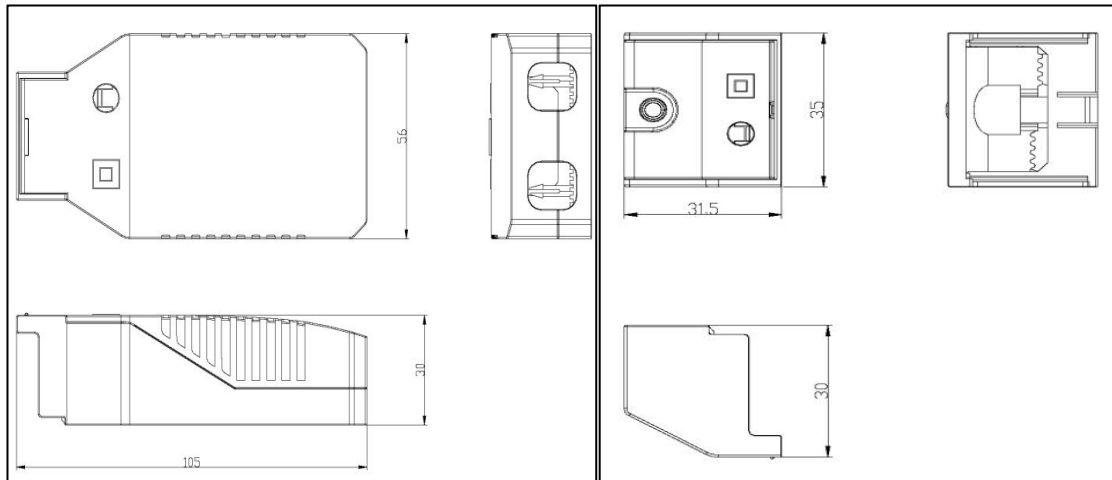

A caps

B caps



Top end caps coding: 132021T0079-1
 Bottom end caps coding: 132021T0033
 Strain relief coding: 132038T0046
 Terminal coding: 126016T0009



Top end caps coding: 132021T0080-1
 Bottom end caps coding: 132021T0035

◆ Wiring & Connections

	Specification item	Value (Unit)
Input	Input wire cross-section	0.5...1.5 mm ² (With A side caps: 0.75...2.5 mm ²)
	Input wire gauge.	16...20 AWG (With A side caps: 14...20 AWG)
	Input wire strip length	7...9mm
Output	Output wire cross-section	0.5...1.5 mm ²
	Output wire gauge.	16...20 AWG
	Output wire strip length	7...9mm

◆ Curve for FLS-42-1050 DALI-2 LD ADV, I_o=1050mA

Lifetime vs. Temperature Curve

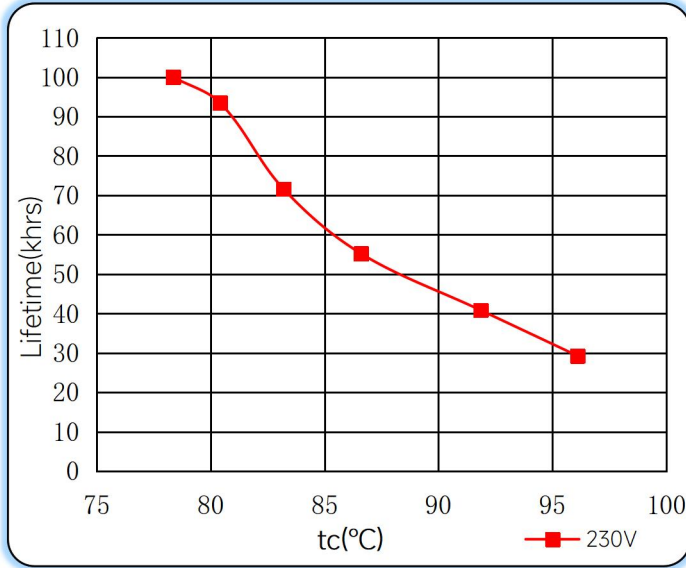

Efficiency vs. Load

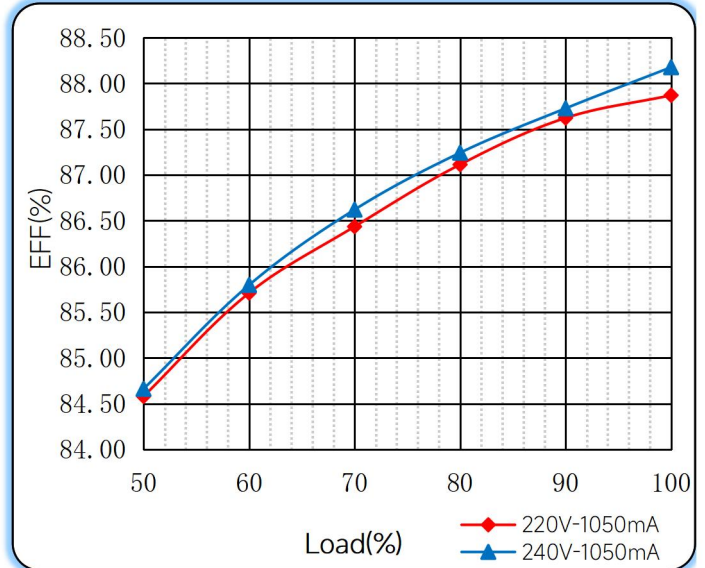

Power Factor Characteristics

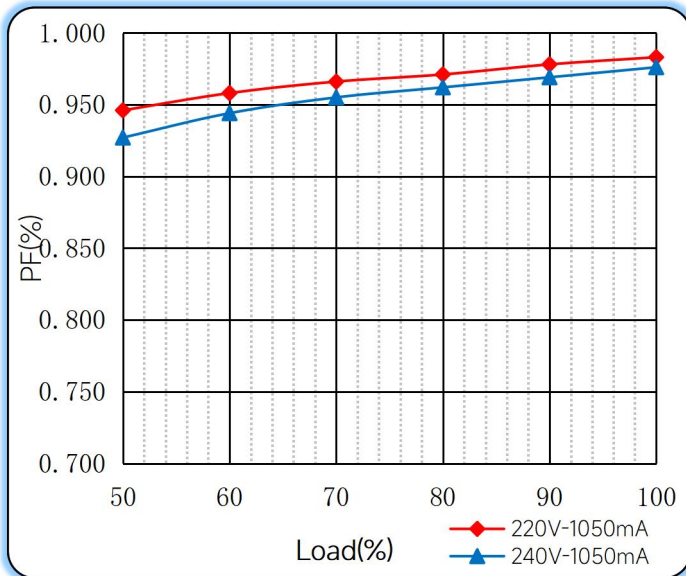

THD vs. Load

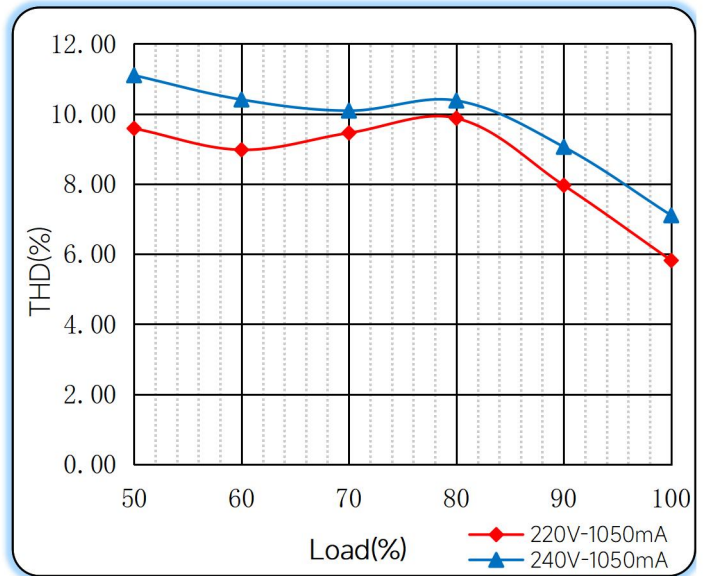

◆ Push dimming operation

Action	Action duration	Function
Short push	<0.5s	Turn on/off
Short push twice	<0.5s	LED on: Save current brightness level LED off: Delete saved level and turn on at 100% brightness
Short push five times	<3s	Quit Corridor mode
Long push	0.5-14s	Dimming up or down
Long push	15s-2mins	Sync all LEDs to be 100% brightness
Long push	>2mins	Enter Corridor mode - LED keep 100% brightness for 2mins. Then brightness will turn to be 10% within 32s if no action during 2mins 100% brightness.

Note:

- 1.The factory default brightness is at 100%.
- 2.Up to 30 drivers can perform the PUSH dimming at the same time when utilizing one common push button
- 3.The maximum length of the cable from the push button to the last driver is 200 meters.

◆ **Corridor mode**

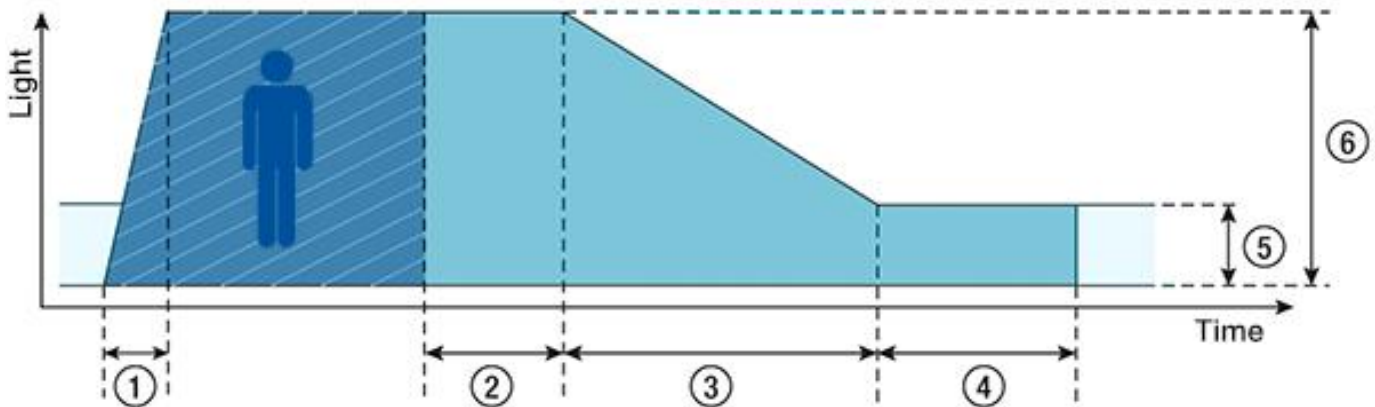

- ◆ ① **Fade-in time(0.5s)**: the time that starts as soon as the presence of a person is detected. During the fade-in time the luminous intensity is faded up to the presence value.
- ◆ ② **Run-on time(120s)**: the time that starts as soon as the presence of a person is no longer detected. If the presence of a person is detected again during the run-on time the run-on time is restarted from zero. If no presence is detected during the run-on time the fade time is started as soon as the run-on time expires.
- ◆ ③ **Fade time(32s)**: the time during which the luminous intensity is faded from the presence value to the absence value.
- ◆ ④ **Switch-off delay (Never Off)**: the time during which the absence value is held before the lighting is switched off. Depending on the profile selected the switch-off delay may have different values or may not be defined.
- ◆ ⑤ **Absence value(default: 10 %)**: the luminous intensity when there is no person present.
- ◆ ⑥ **Presence value (default: 100 %)**: the luminous intensity when persons are present.

◆ **Operating window**

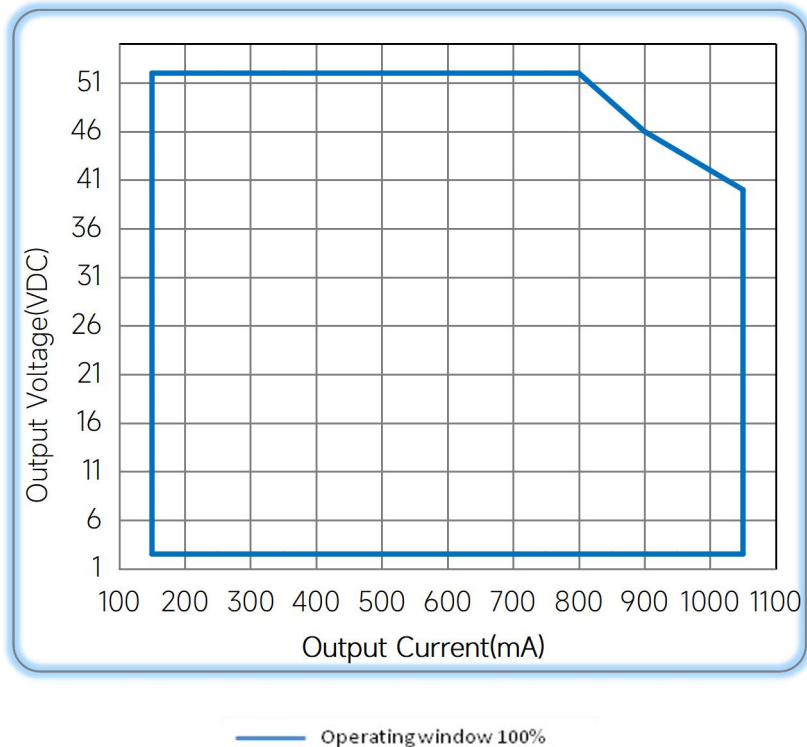

◆ **Revision Updates**

ITEM	BEFORE	AFTER	VERSION	DATE
Initial			A	2022/09/09
Protection		Updated	B	2023/02/06

Tel: +86-0757-86256822, +86-0757-86256831

E-mail: sales@eaglerise.com

Website : <https://lighting.eaglerise.com>



EAGLERISE



Manual