

Input voltage	Output voltage	Output current	Output power	Efficiency	Size
9-40V DC	24V DC	6 Amps	144 Watts	92.7%	74*74*32mm

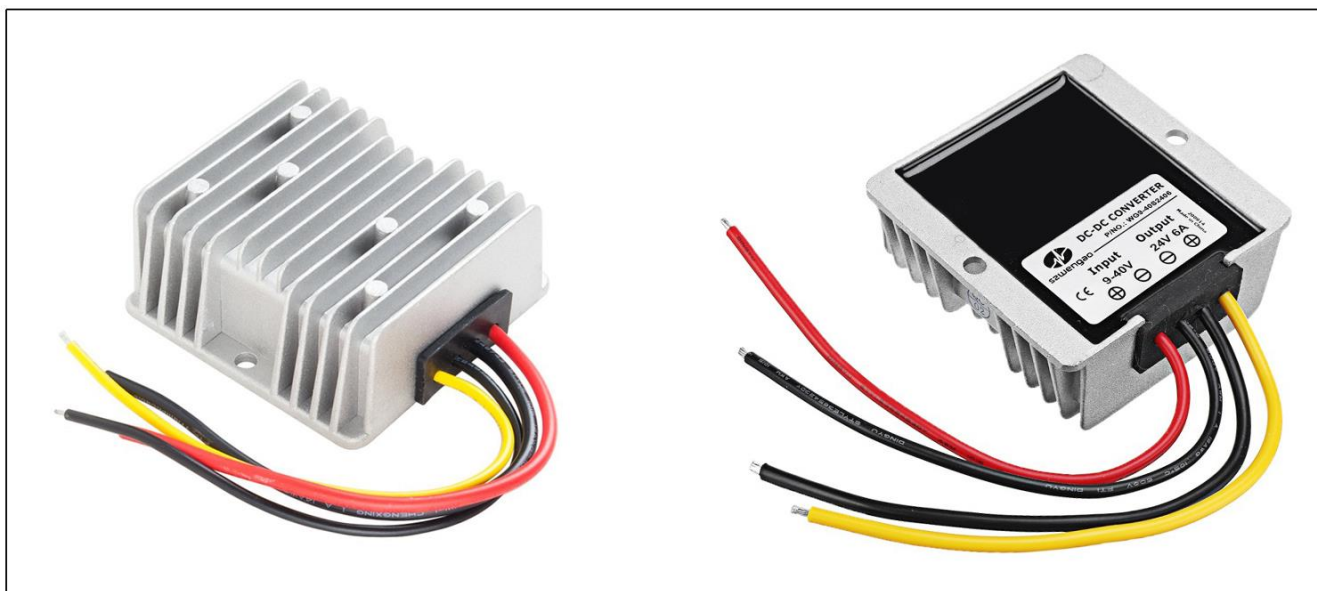

The WG9-40S2406 is a Non-isolated DC-DC converter that uses a synchronous rectification technology, and features high efficiency and power density. It has the dimensions of 74mm x 74mm x 32mm (2.91 in. x 2.91 in. x 1.26 in) and provides the rated output voltage of 24 V and the maximum output current of 6A.

### Features

- Design meeting RoHS / CE
- High efficiency: 92.7% (@ 24Vin, 25°C)
- Import capacitors, high reliability
- Input transient absorption protection
- Support -40 °C environment
- 100% full load burn-in test
- Short circuit, Over load, Low voltage protections
- Remote ON/OFF control (optional)
- Waterproof level IP68
- 2 Years warranty

### Applications

- Industrial
- Alternative Energy
- Golf Cart
- Forklift
- Electromotor
- Telecommunications
- Boat & Yacht
- Medical
- LED Marketplaces and so on.

### Model naming method

**WG9-40S2406**

**WG** : "szwengao" company name

**9-40** : Input rated voltage

**S** : Single output type

**24** : Output voltage

**06** : Output current

**Electrical Specifications**

Conditions: TA = 25 °C (77°F), Airflow = 1 m/s (200LFM), Vin =12V, Vout =24V, unless otherwise specified.

Parameter	Min.	Typ.	Max.	Units	Remarks
<b>Absolute maximum ratings</b>					
Operating ambient temperature	-40	-	+50	°C	
Shell ambient temperature	-40	-	80	°C	
Storage temperature	-55	-	100	°C	
Operating humidity	5	-	95	%	Non-condensing
Atmospheric pressure	62	-	106	Kpa	
Altitude	-	-	4000	m	
Cooling way	-	-	-		Natural cooling
<b>Input characteristics</b>					
Input voltage	9	12/24	40	V	-
Max. input voltage	-	-	40	V	Continuous
Undervoltage shutdown	7.8	8.0	8.2	V	Automatic recovery
Undervoltage recovery	8.5	8.6	8.7	V	Automatic recovery
Max. input current	-	-	22	A	Vin =8.1V; Iout =6A
No load current	-	55	58	mA	Vin =12V
Positive electrode cable	14	-	-	AWG	If the wire length is greater than 50cm, it is recommended to use a thicker wire diameter.
Negative electrode cable	14	-	-	AWG	
Enable PIN cable	22	-	-	AWG	If the product has this feature
Fuse	-	30	-	A	Input positive has built-in fuse
<b>Output characteristics</b>					
Efficiency	-	92.7	-	%	Vin =12V; Iout =6A
Output voltage	23.9	24.0	24.3	V	Vin =12V; Iout =6A
Regulator accuracy	-	±1	-	%	
Voltage regulation	-	±1	-	%	
Load Regulation	-	±1	-	%	
Overvoltage protection	-	-	-	V	
Output current	0	-	6	A	
Overcurrent protection	9.7	9.9	10.2	A	Vin= 12V
External capacitance	0	3000	4000	μF	
Output ripple and noise	-	170	230	mVp-p	Vin =9-40V; Iout=6A, Oscilloscope bandwidth: 20 MHz
Output voltage rise time	-	7.1	8.3	mS	
Boot delay time	-	17.1	20	mS	
Out voltage overshoot	-	1	2	%	Vin =12V, 50%-75% Load step
Over temperature protection	-	-	-	°C	
Short circuit protection	-	-	-		Long-term (4 hours) short circuit is not damaged, Hiccup mode
Positive electrode cable	16	-	-	AWG	If the wire length is greater than 50cm, it is recommended to use a thicker wire diameter.
Negative electrode cable	16	-	-	AWG	



Safety and EMC features				
Anti-electric Strength	Input to Output	-	V	Leakage current $\leq 3.5\text{mA}$ , 1min, no breakdown, no arcing
	Input to Shell	$\geq 500$	V	
	Output to Shell	$\geq 500$	V	
Insulation resistance	Input to Output	$\geq 50$	M $\Omega$	Test voltage = 500V
	Input to Shell			
	Output to Shell			
Other characteristics				
Weight	$\leq 290$		g	
Package	White box			
MTBF	$\geq 200,000$		H	Vin= 24V; Iout= 6A
Switching frequency	$80\pm 10$		KHz	

**Characteristic Curves**

Conditions: TA = 25°C (77°F), Vin = 12 V, Vout = 24V , unless otherwise specified.

**Figure 1, Efficiency**

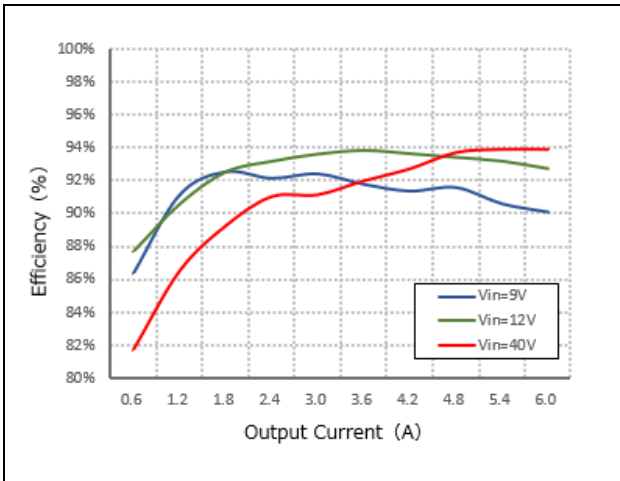

**Figure 2, Power dissipation**

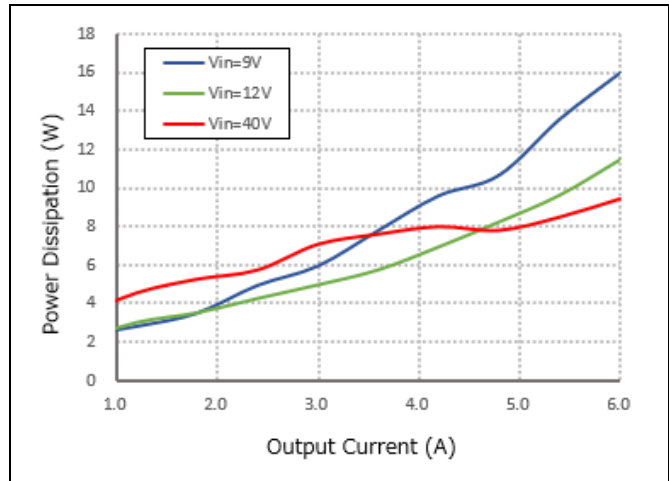

**Figure 3, Input V-I, Iout=6A**

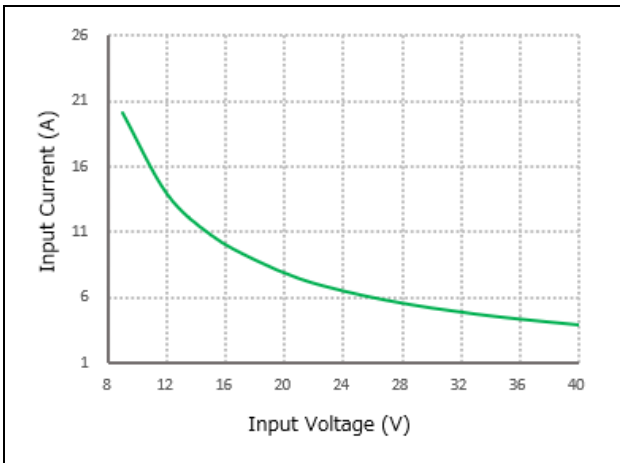

**Typical Waveforms**

Conditions: TA = 25° C (77° F), Vin = 12V, unless otherwise specified.

**Figure 4, 25% - 50% load dynamic**

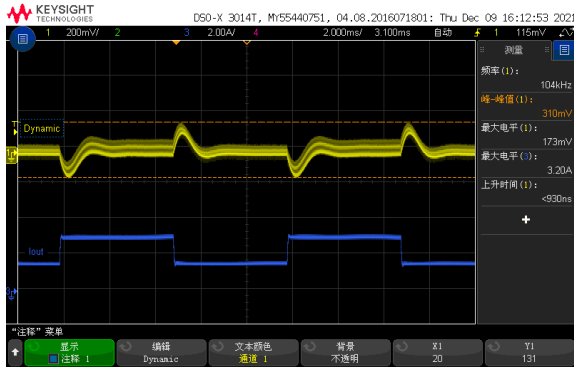

**Figure 5, 50% - 75% load dynamic**

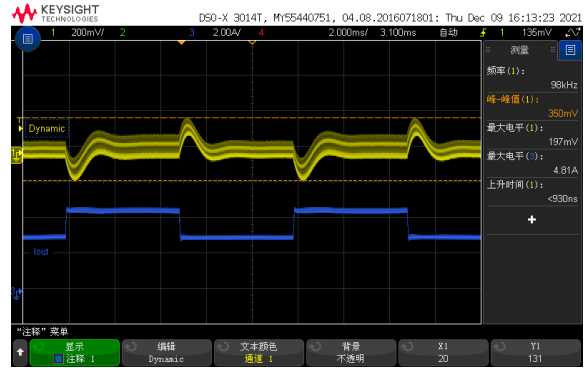

**Figure 6, Output voltage established (Iout = 6A)**

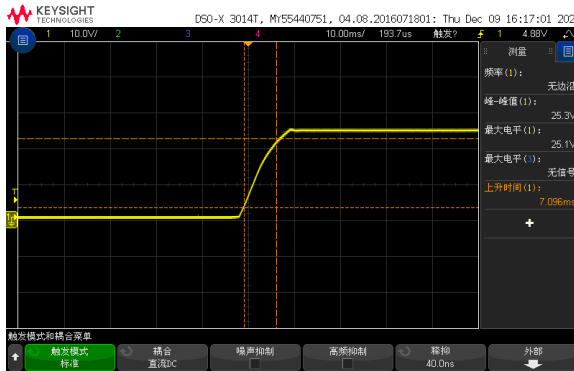

**Figure 7, Output ripple & noise (Iout = 6A)**

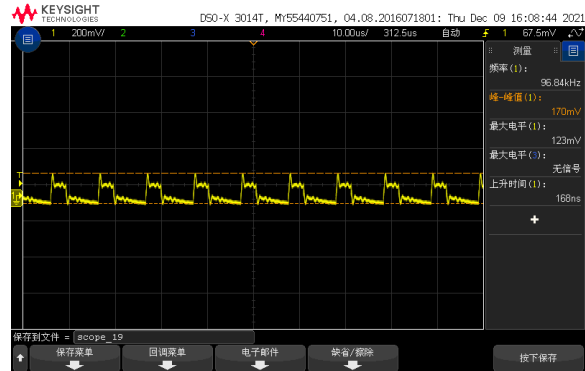

**Figure 8, Boot delay time**

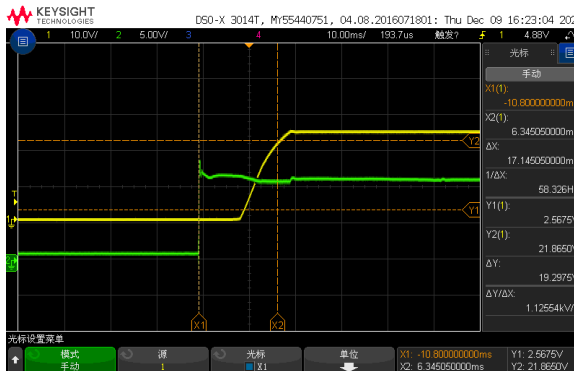

**Figure 9, Short-circuit & Output voltage**

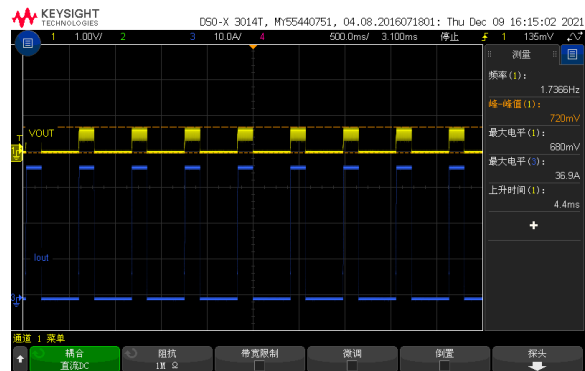



**Feature Description**

**Remote On/Off (EN) (Optional)**

Logic Enable	Low level (0 - 9Vdc)	High level (9-40Vdc)	Left open
Positive logic	Off	On	Off

**Various circuits for driving the EN**

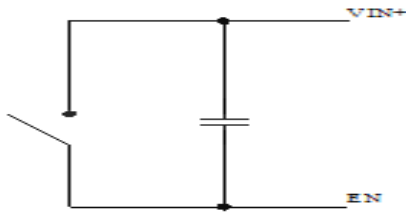

Simple control

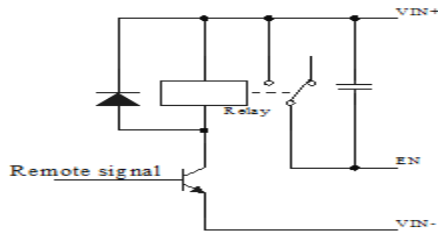

Transistor control

**Input Undervoltage Protection**

The converter will shut down after the input voltage drops below the under-voltage protection threshold for shutdown. The converter will start to work again after the input voltage reaches the input under voltage protection threshold for startup. For the Hysteresis, see the Protection characteristics.

**Output Overcurrent Protection**

The converter equipped with current limiting circuitry can provide protection from an output overload or short circuit condition. If the output current exceeds the output overcurrent protection set point, the converter enters hiccup mode. When the fault condition is removed, the converter will automatically restart.

**Wiring Instructions**

The input and output of this product is terminals. The user should ensure that the input and output wires and terminals are connected reliably, and pay attention to the wire diameter to meet the requirements of the power supply current. If the cable to be used is long, it needs Considering the voltage drop of the wire, if the voltage drop is too large, the voltage output at the load end may not meet the load demand. In this case, consider using a thicker wire diameter or reducing the length of the wire. Generally, if long wiring is required. Long line should be used on the side where the current is relatively small. For example, this product is a step-down product, so long lines should be used on the input side.



**Thermal Consideration**

Sufficient airflow should be provided to help ensure reliable operating of the WG9-40S2406

Therefore, thermal components are mounted on the top surface of the WG9-40S2406 to dissipate heat to the surrounding environment by conduction, convection, and radiation. Proper airflow can be verified by measuring the temperature at the middle of the base plate.

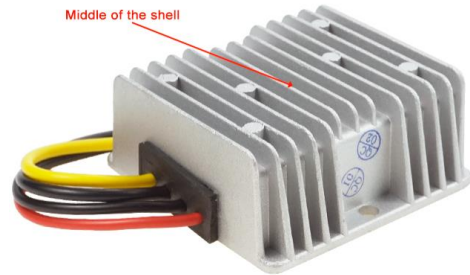

 **Dimension**

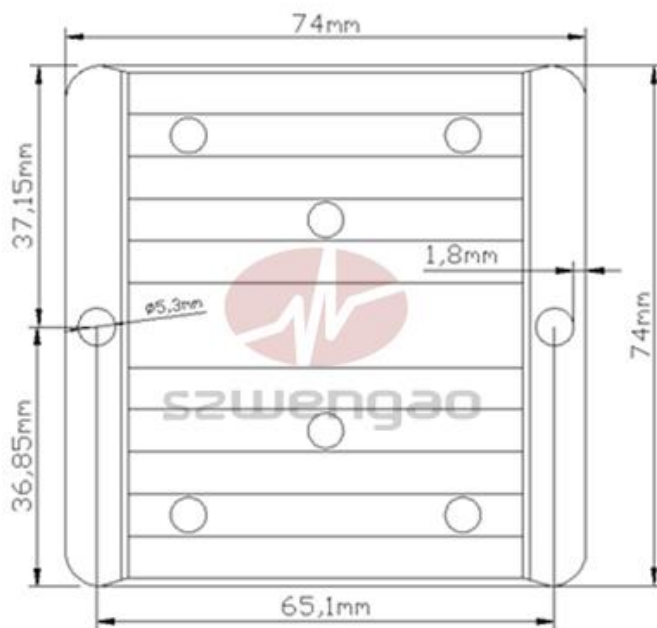

**Shenzhen Wengao Electronic Co., Ltd**

A: 2/F A, Bldg.A2, Anle Ind. Hangcheng RD., Xixiang Street, Baoan Dist., Shenzhen, China 518102

T: +86 755 29418061

F: +86 755 29418061

E: [info@wengaoelec.com](mailto:info@wengaoelec.com)

W: [www.wengaoelec.com](http://www.wengaoelec.com)