

Smart LED Floodlight RGB+CCT 30W

30 WATT

WIDE ANGLE 160°

LL-FL-30W

LINEAR LUX
LED LIGHTING SOLUTIONS



The “SMART” series of LED RGB+CCT floodlights range from 10 to 200W.

RGB colour mixing and white hue adjustment allows the user to select any colour desired. As well as dimming and onboard colour changing programs.

Simple control from either a wireless handheld remote or wallplate, or both. This system also be expanded to allow Mobile App and Zigbee control with added expansion modules.

Up to 8 individual zones can be set for large scale installations

Power

Watts	30 W
Voltage Input	12~20 VDC
Current Input	3.6A @ 12V

Light Output

Colour	Red, Green, Blue (primary colour mix) 2700~6500°K (warm to cool white)
Lumens	2800 LM
Dimmable	0~100% (all colours)
Beam Angle	160°
CRI	>80

Control

Signal Type	2.4GHz Wireless remote control
Control Distance	30m (mesh) Floodlights will transmit the control signal to one another like a mesh network.
Smart Control	WiFi App & Zigbee (requires expansion modules)

Dimensions

Width	167 mm
Height	200 mm
Height (inc bracket)	227 mm
Depth	40 mm

Material

Housing	Aluminium (textured black) Glass
---------	-------------------------------------

Environmental

Protection	IP65
Working Temperature	-20~+45°C



Dimensions

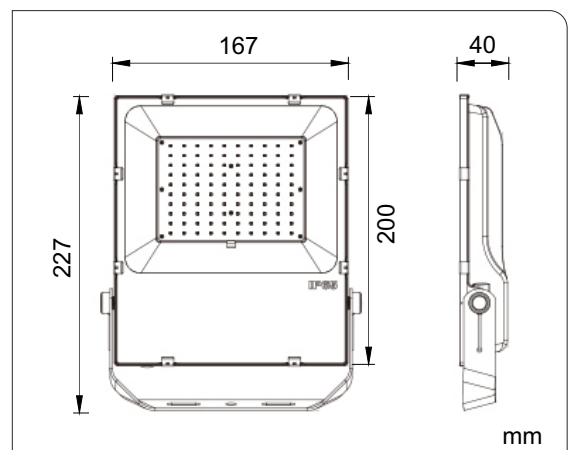

All data taken @ 25°C

Connection and Control Diagram

