

Introduction

5 in 1 (Single Color&CCT&RGB&RGBW&RGB+CCT) smart strip controller is our newly developed high-end LED controller controlled by wireless remote controller, also with smart phone control and 4G long distance control (need WiFi box). The controller has auto-transmitting and auto-synchronizing function and with brightness, CCT, RGB, RGBW and RGB+CCT output mode. This controller adopt the widely used 2.4GHz wireless technology with the features of low power consumption, long signal transmitting and strong anti-interference, etc. One compatible remote control many controllers at the same time. Widely used on the controlling of hotel lighting and home lighting.

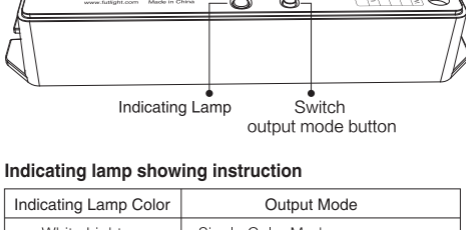

Indicating lamp showing instruction

Indicating Lamp Color	Output Mode
White Light	Single Color Mode
Yellow Light	Dual White Mode
Red Light	RGB Mode
Green Light	RGBW Mode
Blue Light	RGB+CCT Mode

Technical Data

Working Temperature: -20~60°C
 Input Voltage: DC12V~24V
 Output: 6A/Channel
 Total Output Max: 15A
 Connection: Common anode

RF: 2.4GHz
 Transmitting power: 6dBm
 Control Distance: 30m
 Size: 124*38*23mm
 Weight: 60g

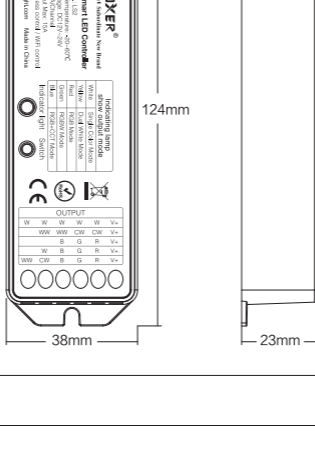

Remote Controller

Compatible with these remote controls (Purchased separately). For more details, pls read the remote instruction.

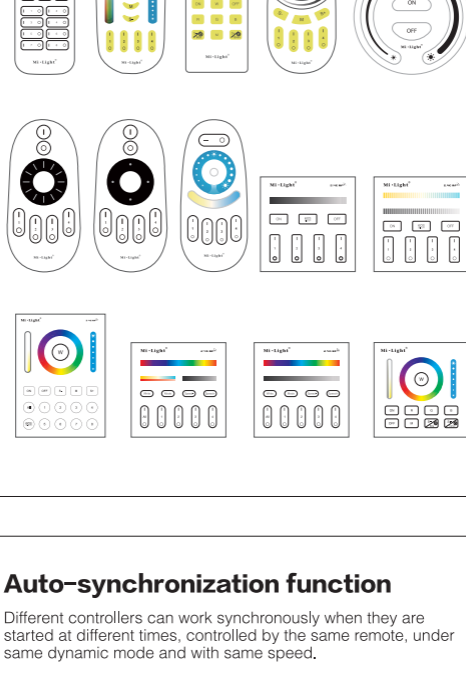

Auto-synchronization function

Different controllers can work synchronously when they are started at different times, controlled by the same remote, under same dynamic mode and with same speed.

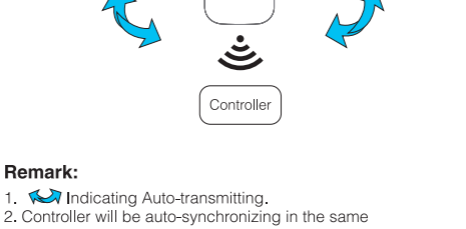

Remark:

- Indicating Auto-transmitting.
- Controller will be auto-synchronizing in the same dynamic modes and within 30m controlling distance.

Auto-transmitting Diagram

One strip controller can transmit the signals from the remote control to another controller within 30m, as long as there is a strip controller within 30m, the remote control distance can be limitless.

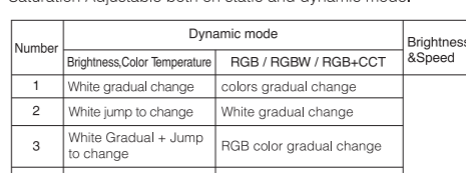

Dynamic Mode Sheet

Saturation Adjustable both on static and dynamic mode.

Number	Dynamic mode		Brightness & Speed
	Brightness, Color Temperature	RGB / RGBW / RGB+CCT	
1	White gradual change	colors gradual change	Adjustable
2	White jump to change	White gradual change	
3	White Gradual + Jump to change	RGB color gradual change	
4	NC	7 colors jump to change	
5	NC	Random jump to change	
6	NC	RED Gradual + Jump to change	
7	NC	Green Gradual + Jump to change	
8	NC	Blue Gradual + Jump to change	
9	NC	White Gradual + Jump to change	

Controller connect to LED strip diagram

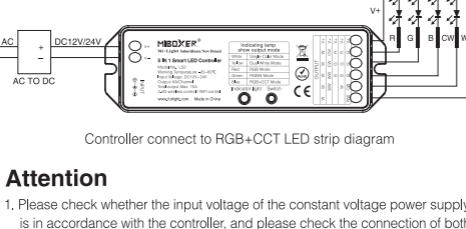
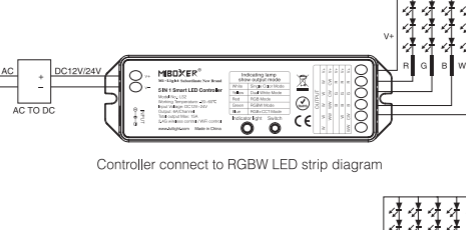
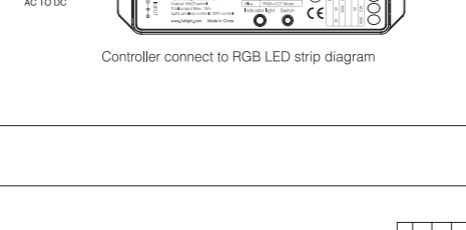
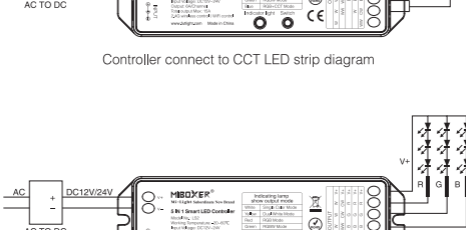
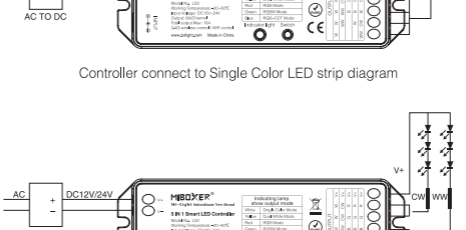

Attention

- Please check whether the input voltage of the constant voltage power supply is in accordance with the controller, and please check the connection of both the cathode and anode, otherwise the controller will be broken.
- Please don't connect wires with power on. Please turn on again only when it is in right connection and no short circuit.
- Please do not use the controller in the place with widely range metal area or strong electromagnetic wave nearby, otherwise, the remote distance will be seriously affected.